

CHAPTER 8 – INTERSECTIONS

TABLE OF CONTENTS

Section	Title	Page
8.1	General	8-1
8.1.1	Intersections as Conflict Locations.....	8-1
	A. Basic Intersection Design	8-1
8.2	Intersection Design Criteria	8-1
8.2.1	Location of Intersections	8-1
8.2.2	Lane Alignment.....	8-1
8.2.3	Angle of Intersection.....	8-1
8.2.4	Horizontal Alignment and Vertical Profile	8-1
	A. Horizontal	8-1
	B. Vertical	8-2
	C. Prevailing Street Grade.....	8-2
8.2.5	Exclusive Left Turn Lanes	8-2
	A. Warrants for Signalized Intersections.....	8-2
	B. Warrants for Unsignalized Intersections.....	8-2
	C. Design Criteria.....	8-2
8.2.6	Exclusive Right Turn Lanes.....	8-3
	A. Warrants for Right Turn Lanes.....	8-3
	B. Design Criteria.....	8-3
	C. Pedestrian Refuge	8-3
8.2.7	Acceleration/Deceleration Lanes	8-3
	A. Deceleration.....	8-3
	B. Acceleration.....	8-3
8.2.8	Design Vehicles.....	8-3
	A. SU-30 (Single Unit Truck)	8-4
	B. B-40 (Bus)	8-4
	C. WB-50 (Large Semitrailer).....	8-4
	D. WB-67 (Large Semitrailer).....	8-4
	E. Other Vehicles	8-4
8.2.9	Curb Returns	8-4
	A. Curb Return Radii.....	8-4
	B. Curb Return Grades	8-5
8.2.10	Traffic Islands.....	8-5
	A. Corner Islands Separating Right Turns.....	8-5
	B. Median Islands Separating Opposing Traffic	8-5
	C. Median Islands on Minor Arterials, Collectors, or Local Streets	8-6
	D. Splitter Islands on Roundabouts	8-7
8.2.11	Traffic Signals, Striping and Signing.....	8-7
8.2.12	Access Ramps	8-7
8.2.13	Right-of-way.....	8-7
	A. Requirements	8-7
	B. Roundabouts	8-7
8.2.14	Intersection Sight Distance	8-7
	A. Minimum Requirements	8-7
	B. Landscaping and Hardscaping	8-7
8.2.15	Channelization	8-7
	A. Intent of Channelization	8-8
	B. Specific Channelization Requirements.....	8-8
8.2.16	Roadway Narrowing.....	8-8

8.2.17 Roundabouts	8-9
8.2.18 Bike Lanes at Intersections	8-9
8.2.19 Pedestrian Requirements	8-9
8.2.20 Drainage	8-9
8.2.21 Pavement Requirements for Arterial/Arterial Intersections	8-9
8.2.22 Intersection Lighting	8-9
8.2.23 Intersection Control	8-9

LIST OF TABLES

Table 8-1 Minimum Curb Return Radii - Loveland (GMA and City Limits).....	8-5
Table 8-2 Curb Return Radii - Fort Collins (GMA and City Limits)	8-5

LIST OF FIGURES

Figures are Located at End of Chapter

Figure 8-1	Vol. Warrants for Left Turn Lanes at Unsignalized Intersection
Figure 8-2	Guidelines for Design of Left Turn Lanes
Figure 8-3	Guidelines for Design Tapers for Left Turn Lanes
Figure 8-4	Traffic Vol. Guidelines for Design Right Turn Lanes
Figure 8-5	Guidelines for Design Lengths of Right Turn Lanes
Figure 8-6	Left Turn Lane Deceleration
Figure 8-7	Commercial High Traffic Volume Driveway
Figure 8-8	Reserved
Figure 8-9	Reserved
Figure 8-10	Exclusive Left Turn
Figure 8-11	Turn Lane Design Criteria
Figure 8-12	Right-of-Way Requirements at Intersection
Figure 8-13	Splitter Island for Mini Roundabouts
Figure 8-14	Mini Roundabout
Figure 8-15	Mini Roundabout Cross Section
Figure 8-16L	Arterial Intersection Right-of-Way Requirements – Loveland (GMA and City Limits)
Figure 8-17	Intersection Grades
Figure 8-18	Right Turn Lane to a Continuous Lane with Pedestrian Refuge
Figure 8-19	Pedestrian Refuge Island/Right Turn Lane
Figure 8-20	Required Spot Elevations for Curb Returns
Figure 8-21	Typical Roundabout

CHAPTER 8 – INTERSECTIONS

8.1 GENERAL

Intersections shall be designed to provide for the safety of motorists, pedestrians, and bicyclists. This chapter is based on criteria from the Institute of Transportation Engineers Traffic Engineering Handbook and AASHTO's **A Policy on Geometric Design of Highways and Streets**.

8.1.1 Intersections as Conflict Locations

By their nature, intersections are conflict locations. Vehicles, pedestrians, and bicycles all cross paths. Each crossing is a conflict point. Intersections contain many conflict points.

A. Basic Intersection Design

The basic design of intersections includes the following objectives:

1. Minimize points of conflict;
2. Simplify areas of conflict;
3. Limit conflict frequency; and
4. Limit conflict severity.

These objectives can be achieved using the design elements presented below.

8.2 INTERSECTION DESIGN CRITERIA

8.2.1 Location of Intersections

For intersection location criteria, refer to **Chapter 9, Access Requirements and Criteria**, the current Master Street plan for each Local Entity and street layout criteria for the Local Entity.

8.2.2 Lane Alignment

All lanes shall be in general alignment through each intersection, however a maximum 2-foot shift is allowed across an intersection without a variance approval by the Local Entity Engineer..

8.2.3 Angle of Intersection

New crossing roadways should intersect at 90 degrees whenever possible. In no case shall they intersect at less than 80 degrees or more than 100 degrees.

8.2.4 Horizontal Alignment and Vertical Profile

A. Horizontal

The horizontal alignment of streets through an intersection shall be designed in conformance with **Tables 7-3 and 7-4**. Intersections may be placed on horizontal curves, provided that the tangent lengths given in **Tables 7-3 and 7-4** are provided on the minor street and the required sight distance is met.

B. Vertical

The street profile grade shall not exceed 4 percent on the approach to the intersection, as measured along the centerline of the street for a minimum distance equal to the tangent length for the street classification. The profile grade within the intersection streets shall not exceed 3 percent as shown on **Figure 8-17**.

C. Prevailing Street Grade

The grade of the street with the higher classification shall prevail at intersections. The lesser street shall adapt to the grade of the Major street. Grading of adjacent property and driveways shall adapt to the street grades. When roads are of equal classification, the Local Entity Engineer shall determine which street grade prevails.

8.2.5 Exclusive Left Turn Lanes

Exclusive left turn lanes shall be provided on all arterial streets and other streets wherever left turn lanes are specified as needed by an access plan, required by these Standards or warranted and approved by the Local Entity Engineer. The Designer shall use information in the TIS to determine whether an exclusive left turn lane is warranted on non-arterial streets. To determine warrants, the following criteria shall be followed (modified) from the National Cooperative Highway Research Program Report 279 (NCHRP 279):

A. Warrants for Signalized Intersections

A separate left turn lane shall be required if one of the following criteria is met:

1. The left turn design volume is at least 20 percent of total approach volumes, or
2. The left turn design volume exceeds 100 vph in peak periods, or
3. The LOS criteria in **Chapter 4, Transportation Impact Studies**, are not satisfied without a separate left turn lane.

B. Warrants for Unsignalized Intersections

Left turn lanes may be required at approaches to intersections for which the combination of through, left, and opposing volumes exceeds warrants shown in **Figure 8-1**. The Local Entity Engineer will determine which peak hours to consider in this evaluation.

C. Design Criteria

Left turn lanes shall be designed to provide the following functions:

1. A means for safe deceleration outside the high speed through lane.
2. A storage length long enough for left turning vehicles so that signal phasing can be optimized and intersection delay minimized.
3. A means of separating movements at unsignalized intersections to reduce left turn impacts on other flows.

The design elements for a left turn lane are as shown in **Figure 8-11**. The elements are the approach taper, bay taper, lengths of lanes, width of lanes, and departure taper. For bay taper and approach taper lengths, see **Figure 8-2** and **Figure 8-3**. The required left turn lane widths shall be as specified in either **Table 7-1** or **7-2**.

8.2.6 Exclusive Right Turn Lanes

Exclusive right turn lanes shall be provided at locations where they are specified as needed by an access plan, or where required by the applicable TIS, approved by the Local Entity Engineer.

A. Warrants for Right Turn Lanes

Figure 8-4 provides guidelines and warrants for whether a right turn lane shall be provided at intersections or accesses.

B. Design Criteria

Right turn lanes shall be designed to accomplish the following functions:

1. Provide a means of safe deceleration outside the high speed through lane.
2. Provide a separate storage area for right turns to assist in the optimization of traffic signal phasing.
3. Provide a means of separating right turn movements at stop controlled intersections.

The design elements, as shown in **Figure 8-9**, are the approach taper, bay taper, lengths of lanes, width of lanes, and departure taper. For approach taper lengths, see **Figure 8-5**.

C. Pedestrian Refuge

Where Pedestrian refuge is required, design it in accordance with Figure 8-19. If a right turn lane turns into an exclusive lane that continues, use Figure 8-18.

8.2.7 Acceleration/Deceleration Lanes

For each high volume driveway and major intersection, acceleration/ deceleration lanes shall be considered. The criteria for the requirements are provided below. The specific designs for these lanes shall be in accordance with NCHRP 279 (1985 Edition) and this chapter.

A. Deceleration

Deceleration lane requirements are given in **Sections 8.2.5 and 8.2.6**.

B. Acceleration

Refer to NCHRP 279 (1985 Edition) for acceleration lane criteria. Fort Collins (GMA and city limits) does not generally want acceleration lanes.

8.2.8 Design Vehicles

As a minimum, intersections shall be designed to accommodate the following AASHTO design vehicles for the specified turns. The minimum allowable intersection turning radii are as follows in accordance with the **AASHTO A Policy on Geometric Design of Highways and Streets**.

A. SU-30 (Single Unit Truck)

All SU-30 vehicles must be able to turn easily from one street to the next and remain in the correct lane for each roadway. This shall be required for all roadways and alleys.

B. B-40 (Bus)

All B-40 vehicles may use more than one traffic lane to complete the turn when turning from the correct lane without crossing into opposing traffic lanes and without tracking onto the curb at corners. This shall apply to all streets.

C. WB-50 (Large Semitrailer)

All WB-50 vehicles may use more than one traffic lane to complete the turn without tracking onto the curb at corners. In addition, the vehicle must make the turn in one forward maneuver not encroaching into opposing traffic lanes. This requirement shall apply to all Arterial/Arterial, Arterial/Collector, Arterial/Connector, Arterial/Local Commercial, Arterial/Local Industrial, Collector/Collector, and Collector intersections at Connectors, Local Commercial, and Industrial streets.

For all other intersections (including mini-roundabouts), the vehicles may use the entire paved surface of the street to negotiate the turn. The vehicle may have to back up to complete the turn.

D. WB-67 (Large Semitrailer).

All modern roundabouts and arterial intersections containing raised medians and channelizing islands shall be designed to accommodate a WB-67 vehicle.

E. Other Vehicles.

For special circumstances other design vehicles may be required by the Local Entity Engineer.

8.2.9 Curb Returns

A. Curb Return Radii

The corner radii shall meet the following requirements in **Table 8-1** or **Table 8-2** unless otherwise approved or required by the Local Entity Engineer.

**Table 8-1
Minimum Curb Return Radii -
Loveland (GMA and City Limits)**

	Local	Collector	Arterial
Commercial Driveways, High Volume Driveway & Alley	15'	20'	20'
Local	20'	20'	30'
Collector	20'	25'	30'
Arterial	30'	30'	35'

**Table 8-2
Minimum Curb Return Radii -
Fort Collins (GMA and City Limits)**

	Local	Collector	Arterial
High Volume Driveway	15'	15'	20'
Alley	5'	5'	5'
Local	20'	20'	25'
Collector	20'	20'	25'
Arterial	25'	25'	25'

For curb returns on a State Highway, CDOT's curb radii requirements shall supersede these Standards.

B. Curb Return Grades

The minimum desirable grade for flowlines around the curb return should be 1 percent. The minimum allowable grade for flowlines around curb returns shall be 0.5 percent.

8.2.10 Traffic Islands.

The following is a list of different types of traffic islands:

A. Corner Islands Separating Right Turns

Standard corner islands shall be used in 4- or 6-lane Arterial/Arterial intersections to channelize traffic where required to provide pedestrian refuge or where required by the Local Entity Engineer. The corner islands shall be designed as raised islands in accordance with Figures 8-18 or 8-19 for a right turn lane continuing to an exclusive lane or for a right turn lane stop condition, respectively. The striping shall be in accordance with the requirements of **Chapter 14, Traffic Control Devices**.

B. Median Islands Separating Opposing Traffic

Median islands are required at all Arterial/Arterial intersections. If raised medians are not required by these Standards, the median islands may be raised or painted. The length of the island shall include the appropriate approach taper, bay taper and length of lane required by the Standards, or supported by another approved resource standard. The design shall be in accordance with **Construction Drawing 801** and **Figure 8-11** and as follows:

1. No Obstruction. Medians must not obstruct the minimum left turn radius for the design vehicle(s).
2. Drainage. Landscaped medians shall include drainage facilities to handle sprinkler run-off and nuisance flows. When low maintenance landscaping is used in conjunction with trickle irrigation, drainage requirements may be waived and outfall curb and gutter should be used.

In Fort Collins (GMA and city limits), use barrier curb in accordance with **Construction Drawing 703**. Otherwise, inflow curb and storm drainage inlets and systems shall be provided to carry storm water.

3. Gluedown Curb. Gluedown curb is acceptable for medians when specifically approved by the Local Entity. In Loveland (GMA and city limits), the design must provide for 1 foot of clear distance between the face of the curb and the travel or left turn lane width.
4. Median Islands Required. Median islands are standard on all new 6-lane and 4-lane Arterial streets. These islands shall be designed to provide pedestrian refuge. (See **Chapter 16, Pedestrian Facilities Design and Technical Criteria**, for design requirements.)

C. Median Islands on Minor Arterials, Collectors, or Local Streets

Raised medians may be placed in Minor Arterial, Collector, and all Local streets. If medians are included, they shall be placed in the public right-of-way, and they must meet the following Standards for design:

1. No Obstruction. The medians may not obstruct the design vehicle turns.
2. Visibility. The medians must be placed such that the required visibility in the intersection is not obstructed.
3. Undiminished Use. Medians must be placed so they do not diminish the intersection use.
4. Alignment. Lanes on one side of the intersection must align with the correct lanes on the opposite side of the intersection. Refer to **Section 8.2.2**.
5. Median Maintenance. These medians must be maintained by parties other than the Local Entity. The maintenance responsibility must be defined on the Final Development Plan, Plat or Development Agreement.
6. Public Use. The appropriate Local Entity may use these islands for roadway signing and may choose to remove the medians if it is deemed necessary by that Local Entity.
7. Additional Right-of-way. The Developer shall dedicate all additional right-of-way necessary to include these medians.
8. Compliance with these Standards. The median design must comply with all applicable median criteria in these Standards and the streetscape standards of the Local Entity.

D. Splitter Islands on Roundabouts

In modern roundabout designs, raised splitter islands shall be designed in accordance with Federal Highway Administration Roundabouts to direct traffic and provide pedestrian refuge.

8.2.11 Traffic Signals, Striping and Signing

See Chapter 14, Traffic Control Devices.

8.2.12 Access Ramps

See Chapter 16, Pedestrian Facilities Design and Technical Criteria.

8.2.13 Right-of-way

A. Requirements

All intersection rights-of-way and utility easements shall be dedicated as shown in **Figure 8-12** to provide adequate right-of-way to include sidewalks, access ramps, and utilities. Additional right-of-way may be required at intersections to provide space for additional left or right turn lanes without reducing the widths of standard required facilities.

B. Roundabouts

In Loveland (GMA and city limits), on all Arterials and Major Collectors, additional right-of-way may be required at intersections in conformance with **Figure 8-16L** to accommodate the potential installation of a roundabout in the future.

8.2.14 Intersection Sight Distance

Street intersections shall be designed so that adequate sight distance is provided along all streets. The required sight distance shall be determined by the design speed and grades of the street and the acceleration rate of an average vehicle as prescribed below.

A. Minimum Requirements

All designs must provide minimum safe stopping sight distance in accordance with **Chapter 7, Street Design and Technical Criteria**, and **AASHTO**. In addition, for all streets that intersect with Arterial and Collector streets, the sight distance must be large enough to allow a vehicle to enter the street and accelerate to the average running speed without interfering with the traffic flow on the Arterial or Collector street. The design sight distance values to be used are provided in **Figure 7-16**.

B. Landscaping and Hardscaping

No landscaping or hardscaping shall be permitted within a corner cut that will block the line of sight for pedestrian visibility, (not higher than 24 inches).

8.2.15 Channelization

Channelization refers to physical or visual guides used to separate vehicles, bicycles and pedestrians into particular lanes.

A. Intent of Channelization

Channelization is intended to:

1. Prohibit undesirable or wrong way movements.
2. Define desirable vehicular paths.
3. Encourage safe vehicle speeds.
4. Separate points of conflict wherever possible.
5. Cause traffic streams to cross at right angles and merge at flat angles.
6. Facilitate high-priority traffic movements.
7. Facilitate traffic control scheme.
8. Remove decelerating, stopped, or slow vehicles from high-speed through-traffic streams.
9. Provide safe crossings for pedestrians/bicycles.
10. Provide safe refuge for pedestrians.

B. Specific Channelization Requirements

Channelization shall be required at locations where it is necessary for safety or to protect the operation of the major street. Examples include:

1. Providing raised medians in all Arterials where left turns are prohibited.
2. Providing exclusive turning lanes, with appropriate striping as shown in **Figures 8-18 and 8-19**.
3. Providing travel lanes, with widths as specified in the standard street cross sections. See **Figures 7-1F through 7-13F** or **7-1L through 7-11L**.
4. Raised islands must be large enough to be visible to vehicle drivers. Therefore, no single island, including pedestrian paths and/or pedestrian refuge, shall be smaller than 100 square feet.

8.2.16 Roadway Narrowing

Minor Collector or Local streets may be narrowed at intersections to provide more visibility for pedestrians. This shortens the distance necessary for pedestrians to cross the street. The narrowing shall not encroach into bike lanes or travel lanes. Narrowing may not be used on Major Collectors without any parking lanes, on any Arterials, or where the standard width is necessary. See **Chapter 18, Neighborhood Traffic Safety**, for design criteria.

8.2.17 Roundabouts

8.2.18 Roundabouts are considered a form of traffic control. Roundabouts shall be designed in accordance with the Roundabout Design Manual, included as Appendix I for reference only. Check with the Local Entity Engineer for the most current version of the Roundabout Design Manual. Bike Lanes at Intersections

See Chapter 17, Bicycle Facilities; Chapter 4, Transportation Impact Study; and Chapter 14, Traffic Control Devices.

8.2.19 Pedestrian Requirements

See Chapter 14, Traffic Control Devices, concerning crosswalk requirements and Chapter 16, Pedestrian Facilities Design and Technical Criteria.

8.2.20 Drainage

See Chapter 7, Street Design and Technical Criteria, concerning drainage.

8.2.21 Pavement Requirements for Arterial/Arterial Intersections

All new and reconstructed Arterial/Arterial intersections are required to be designed and constructed with concrete pavement. The concrete paving shall extend on each approach leg to the beginning points of the bay tapers. When existing arterial/arterial intersections are expanded, the use of concrete pavement is only required where one or more complete lanes are added. Refer to **Chapter 10, Pavement Design and Report**. See CDOT M&S Standards for the typical concrete pavement joint locations.

8.2.22 Intersection Lighting

See **Chapter 15, Street Lighting**, for street lighting requirements.

8.2.23 Intersection Control

See **Chapter 14, Traffic Control Devices**, for intersection control.

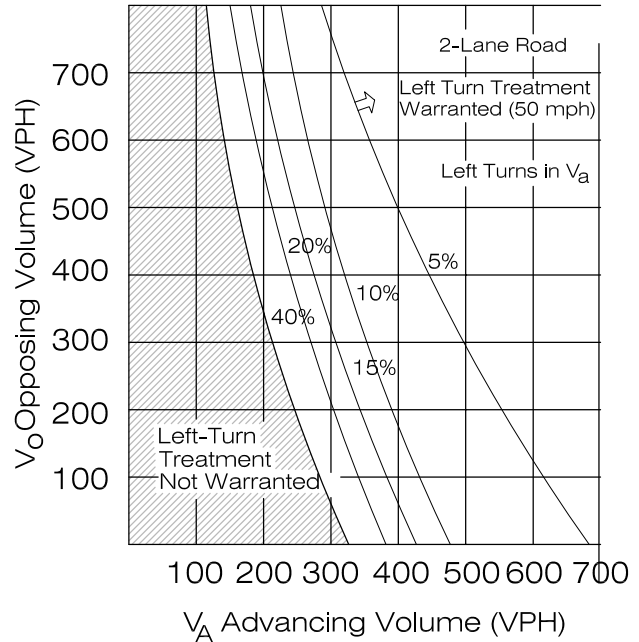
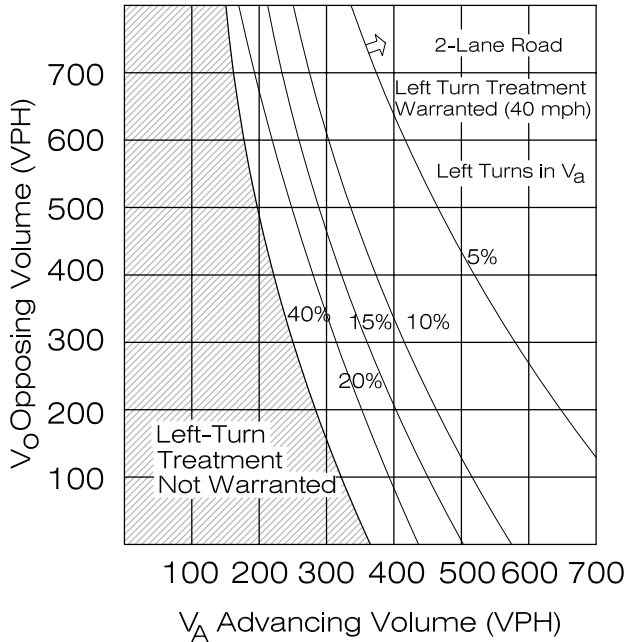

NOTE: When $V_O < 400$ VPH (dashed line). A Left-Turn Lane is not normally warranted unless the advancing volume (V_a) in the same direction as the Left-Turning traffic exceeds 400 VPH ($V_a > 400$ VPH).

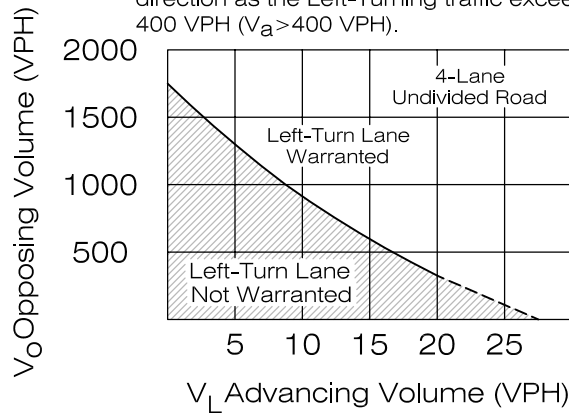

Notes: 1. Left turn lanes are required at all intersections and all-movement accesses on arterial roadways except where roundabouts are provided.

VOLUME WARRANTS FOR LEFT TURN LANES AT UNSIGNALIZED INTER.

**LARIMER COUNTY
URBAN AREA
STREET STANDARDS**

**DESIGN
FIGURE**

REVISION NO:
DATE: 12/14/00

**FIGURE
8-1**

L_d/b -- Length of Taper and Lane for Deceleration and Braking

Functional Basis: To provide sufficient length for a vehicle to decelerate and brake entirely outside the through traffic lanes.

Desirable Design: Deceleration in gear for 3 seconds (occurs over bay taper) followed by comfortable braking to a stopped position.

Design Values For L_d/b

S--Speed (mph)	Length (ft)		
	Total	Lane	Bay Taper
30	235	115	(120)
40	315	155	(160)
50	435	235	(200)
60	530	290	(240)

Minimum Design: Braking begins at 2/3 full lane width, with minimum 50-foot storage. For low speeds only, the following values apply:

Design Values For L_d/b

S--Speed (mph)	Length (ft)		
	Total	Lane	Bay Taper
30	230	50	(180)
35	250	70	(180)
40	280	100	(180)
45	320	140	(180)

L_s -- Length of Lane for Storage (Full Width Lane)

Functional Basis: To Provide sufficient length for a reasonable number of vehicles to queue within the lane without affecting other lanes.

Desirable Design: Based on twice the mean arrival rate (per cycle for signals, per 2-minute period for stop control) during the peak hour of traffic.

Minimum Design: Based on mean arrival rate, with minimum storage for one vehicle.

L_s for Stop Control

DHV (vph)	L_s (ft)
≤60	50-75
61-120	100
121-180	150
>180	200 or more

L_s for Traffic Signal Control

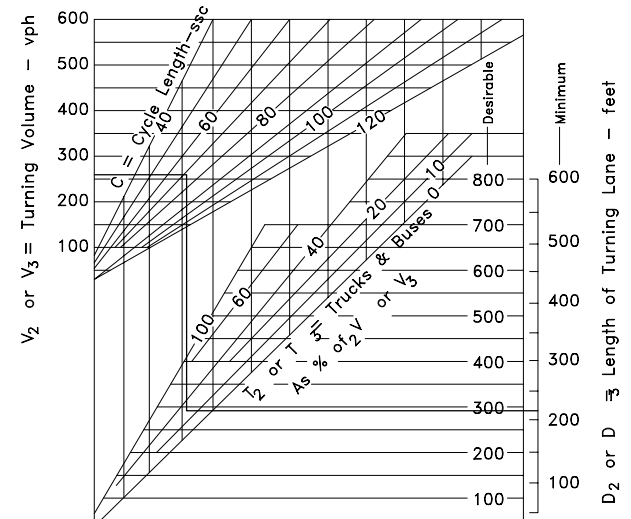

T_a -- Approach Taper Design (ft) (Redirect Taper)

Functional Basis: To provide a smooth lateral transition for all vehicles approaching the intersection.

Form of Alignment: Tangent

Low Speed Design: (<45) Provide a fully shadowed lane.

$$T_a = \frac{W S^2}{60} \quad \begin{array}{l} W = \text{Width of Offset (ft)} \\ S = \text{Speed (mph)} \end{array}$$

Typical Values for T_a^*

S--Speed (mph)	W -- Width of Offset (ft)		
	11	11.5	12
25	115	120	125
30	165	170	180
35	225	235	245
40	295	305	320

*Rounded to nearest 5 ft.

High Speed Design: (≥ 45) Provide a fully shadowed lane.
Design as follows:

$$T_a = WS \quad \begin{array}{l} W = \text{Width or Offset (ft)} \\ S = \text{Speed (mph)} \end{array}$$

S--Speed (mph)	W -- Width of Offset (ft)		
	11	11.5	12
45	495	520	540
50	550	575	600

*Rounded to nearest 5 ft.

T_b -- Bay Taper Design

Functional Basis: To direct left-turning vehicles into the turn lane.

Form of Alignment: Tangent; or reverse curves with 1/3 of the total length comprised of a central tangent.

Desirable Design: For fully shadowed left turn lane.

$$T_b = \frac{W_1 S}{3} \quad \begin{array}{l} W_1 = \text{Width of Lane} \\ S = \text{Speed (mph)} \end{array}$$

Typical Values for T_b^*

S--Speed (mph)	W -- Width of Lane (ft)	
	11	12
30	110	120
40	145	160
50	185	200

*Rounded to nearest 5 ft.

Minimum Design: Taper ratios of 8:1 can be used for tangent bay tapers in constrained locations.

TRAFFIC VOL. GUIDELINES FOR DESIGN RIGHT TURN LANES

**LARIMER COUNTY
URBAN AREA
STREET STANDARDS**

**DESIGN
FIGURE**

REVISION NO:
DATE: 08/07/00

**FIGURE
8-4**

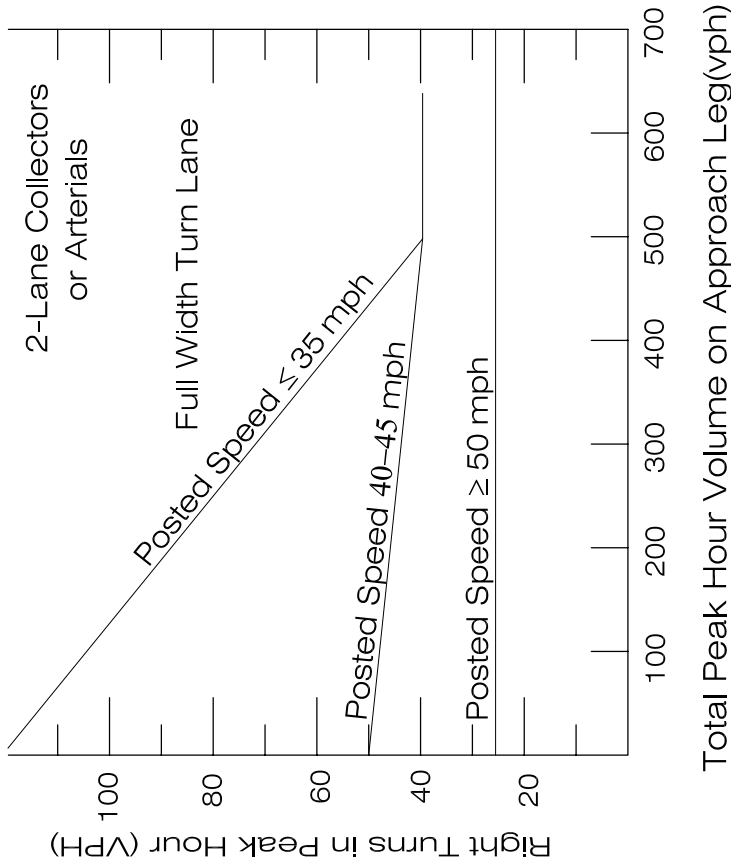
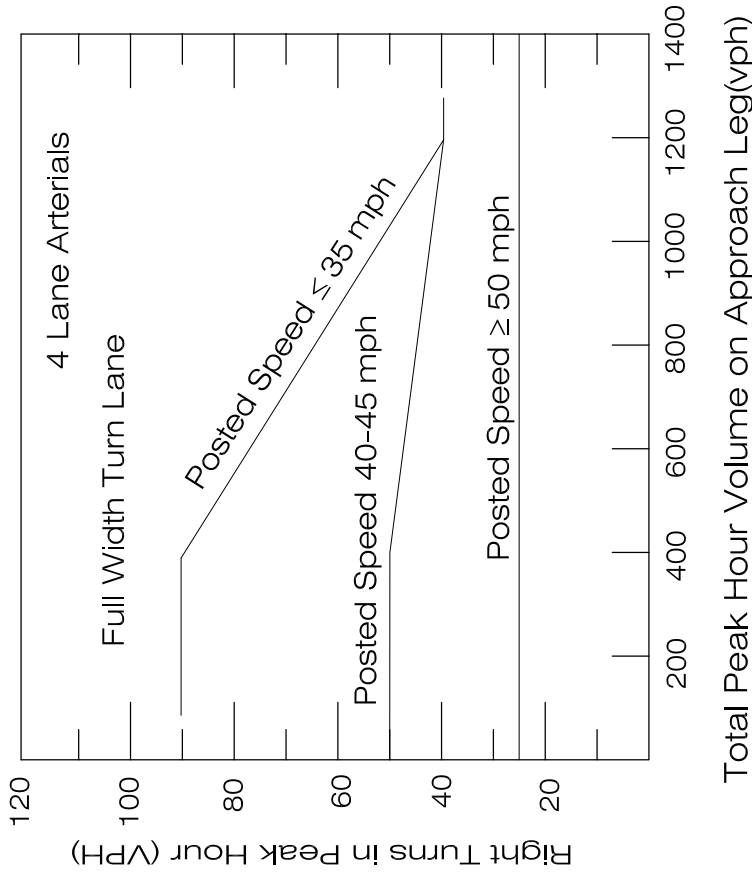

NOTE:
1. Right turn lanes are required on 6-lane arterial when the right turn volume exceeds 200 vph.

L_d / b -- Length of Taper and Lane for Deceleration and Braking (ft)

Functional Basis: To provide sufficient length for a vehicle to decelerate and brake entirely outside the through traffic lanes.

Desirable Design: Deceleration in gear for 3 seconds (occurs over bay taper) followed by comfortable braking to a stopped position or to the design speed of the corner radius.

Design Values For L_d / b

Highway Design Speed, V (mph)	Stop Condition*	Design Speed of Corner Radius (mph)			
		15	20	25	30
30	235	185	160	140	-
35	275	240	213	188	93
40	315	295	265	235	185
45	375	350	325	295	250
50	435	405	385	355	315

*Appropriate for right turn lanes in approaches to stop signs and traffic signals.

$$\text{Bay Taper Length} = \frac{ws}{3}$$

$$T_b = \frac{W_1 S}{3}$$

T_b -- Bay Taper Design

Functional Basis: To direct left-turning vehicles into the turn lane.

Form of Alignment: Tangent; or reverse curves with 1/3 of the total length comprised of a central tangent.

Desirable Design: For fully shadowed left turn lane.

$$T_b = \frac{W_1 S}{3}$$

W_1 = Width of Lane
 S = Speed (mph)

Typical Values for T_b *

S--Speed (mph)	W_1 -- Width of Lane (ft)	
	11	12
30	110	120
40	145	160
50	185	200

*Rounded to nearest 5 ft.

Minimum Design: Taper ratios of 8:1 can be used for tangent bay tapers in constrained locations.

L_s -- Length of Lane for Storage (Full Width Lane) (ft)

Functional Basis: To Provide sufficient length for a reasonable number of vehicles to queue within the lane without affecting other lanes.

Desirable Design: Based on twice the mean arrival rate (per cycle for signals, per 2-minute period for stop control) during the peak hour of traffic.

Minimum Design: Based on mean arrival rate, with minimum storage for one vehicle.

L_s for Stop Control

DHV (vph)	L_s (ft)
≤60	50-75
61-120	100
121-180	150
>180	200 or more

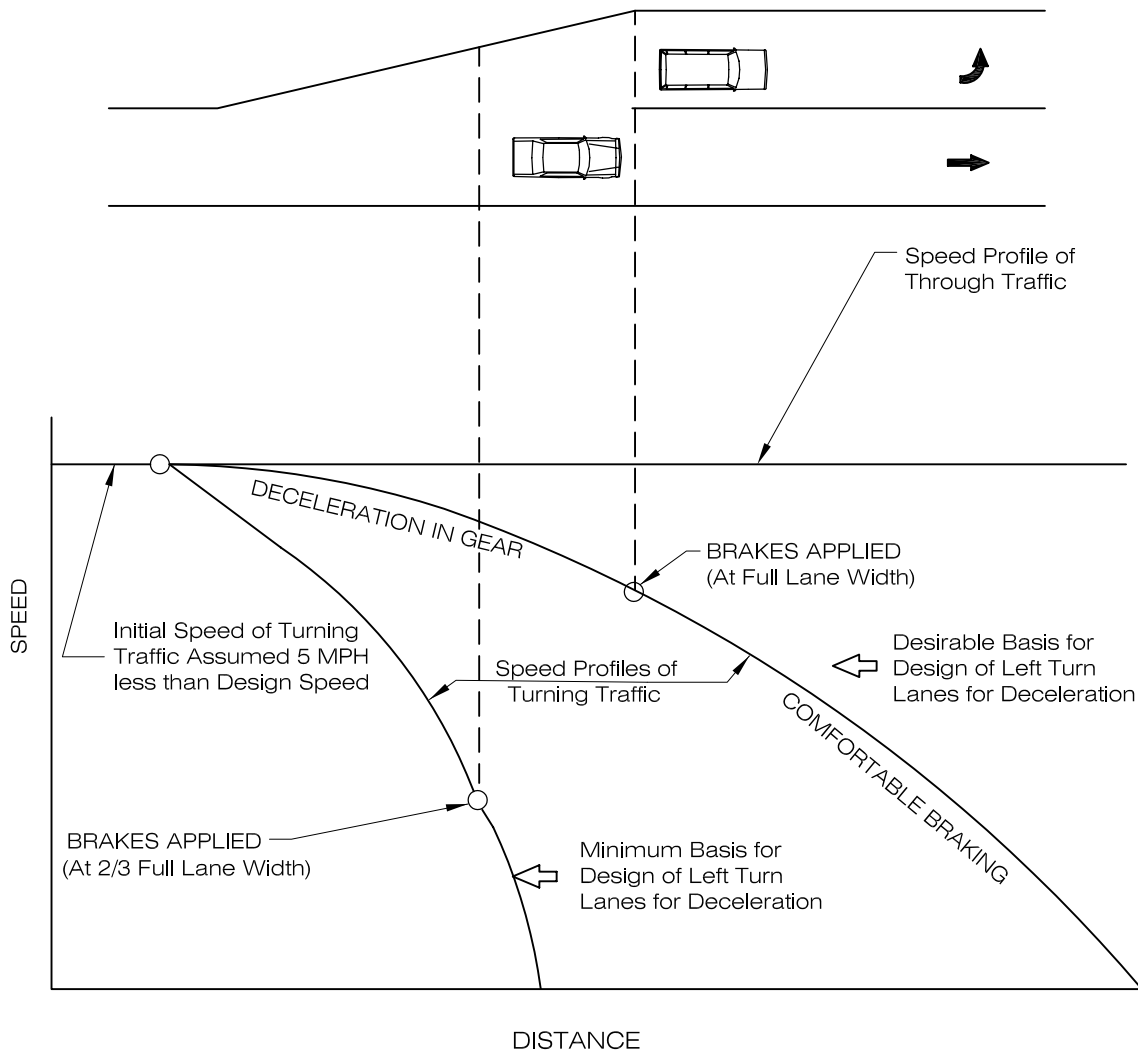

CONCEPTUAL

LEFT TURN LANE DECELERATION

LARIMER COUNTY
URBAN AREA
STREET STANDARDS

DESIGN
FIGURE

REVISION NO:

DATE: 12/14/00

FIGURE

8-6

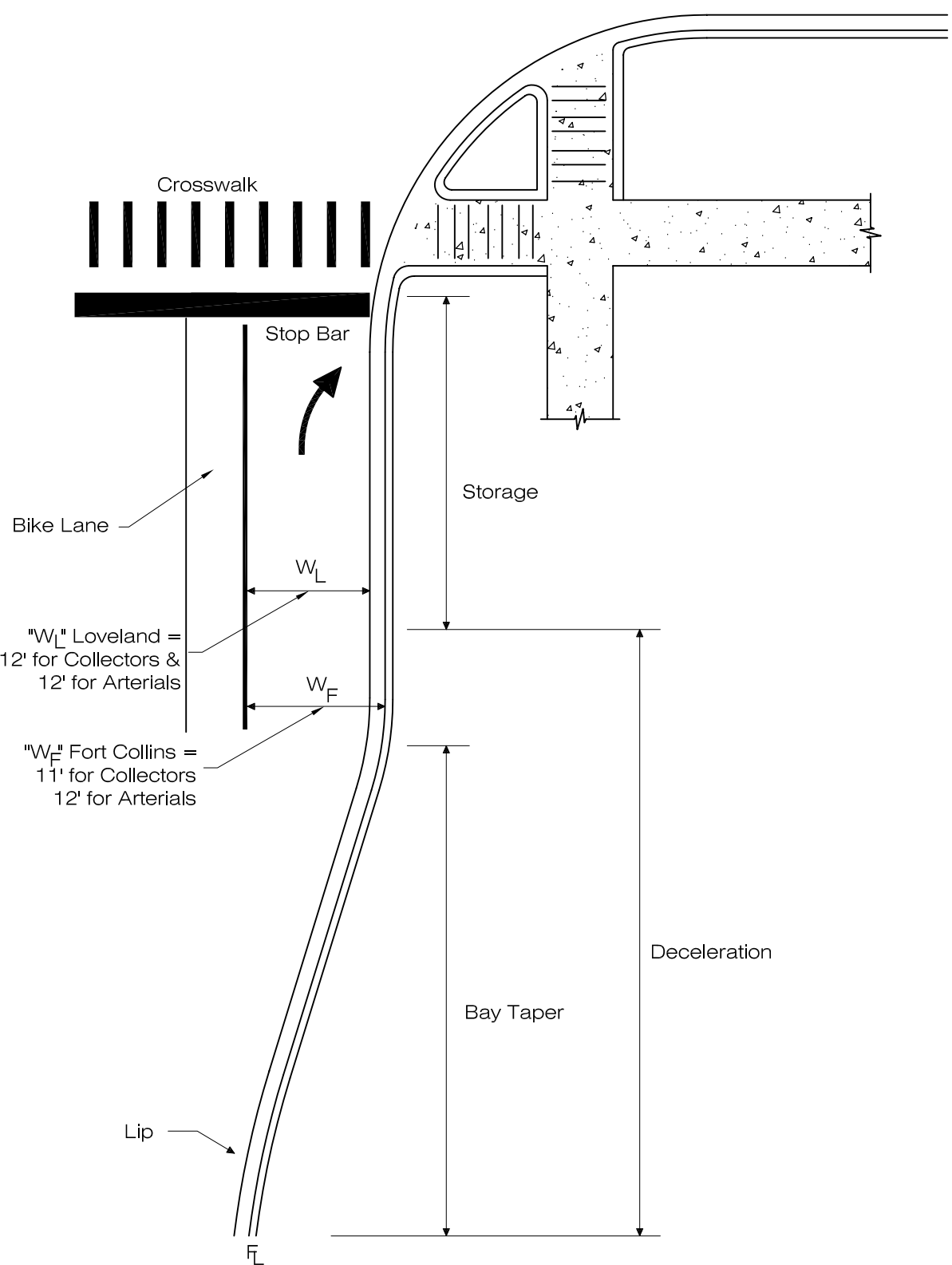

NOTE: 1) Refer to **Figure 8-5** for design requirements.
 2) Provide a 50'± arc length at angle points for a smooth curve.

EXCLUSIVE RIGHT TURN

LARIMER COUNTY URBAN AREA STREET STANDARDS	DESIGN FIGURE	REVISION NO:	FIGURE 8-9
		DATE: 08/07/00	

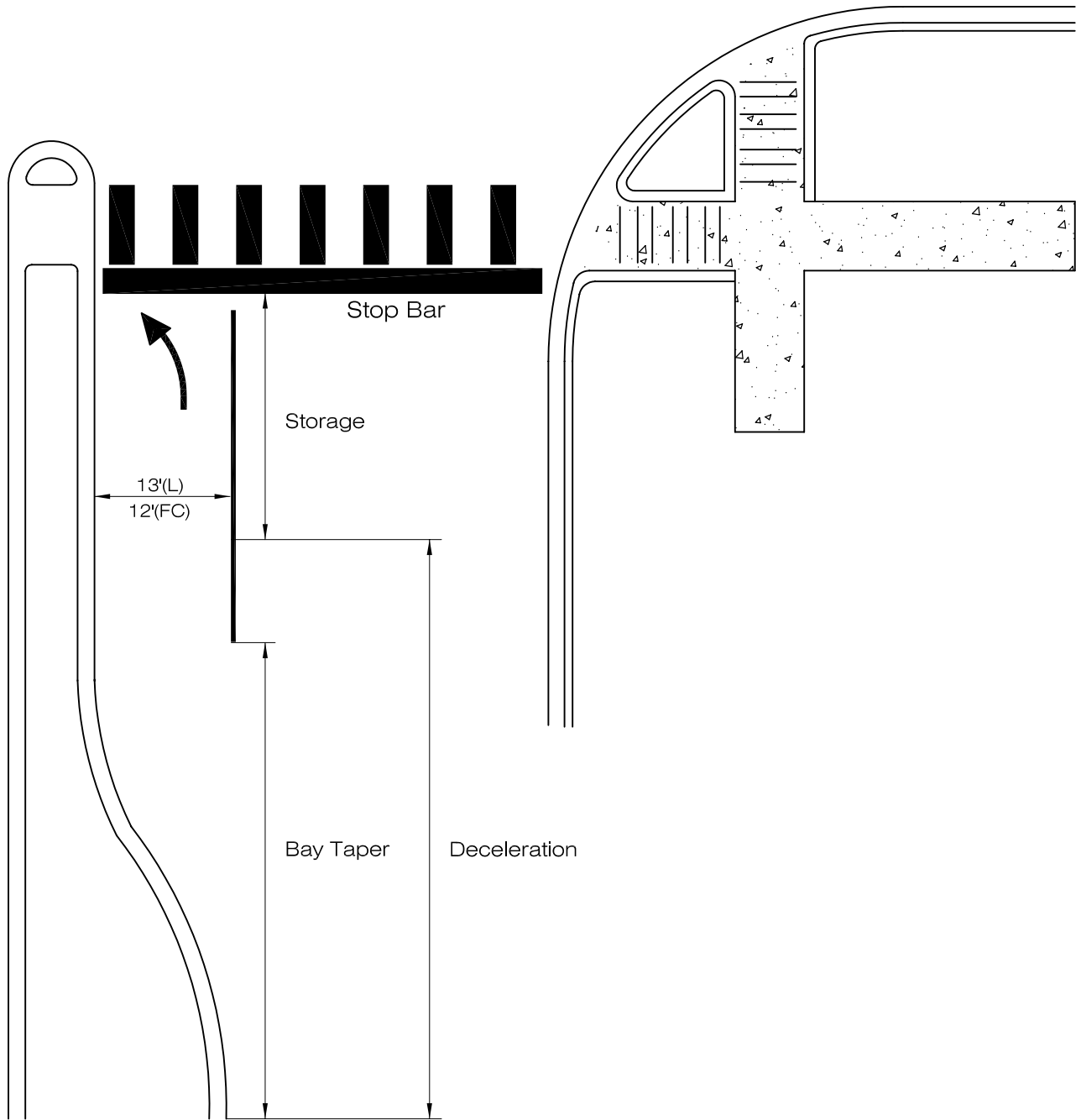

NOTES:

1. If high pedestrian area, then minimum median width is 7' flowline to flowline.
2. Refer to **Figures 8-2, 8-3 and 8-11** for design requirements.
3. Provide a 50'± arc length at angle points for a smooth curve.

EXCLUSIVE LEFT TURN

LARIMER COUNTY
URBAN AREA
STREET STANDARDS

DESIGN
FIGURE

REVISION NO:

DATE: 08/07/00

FIGURE

8-10

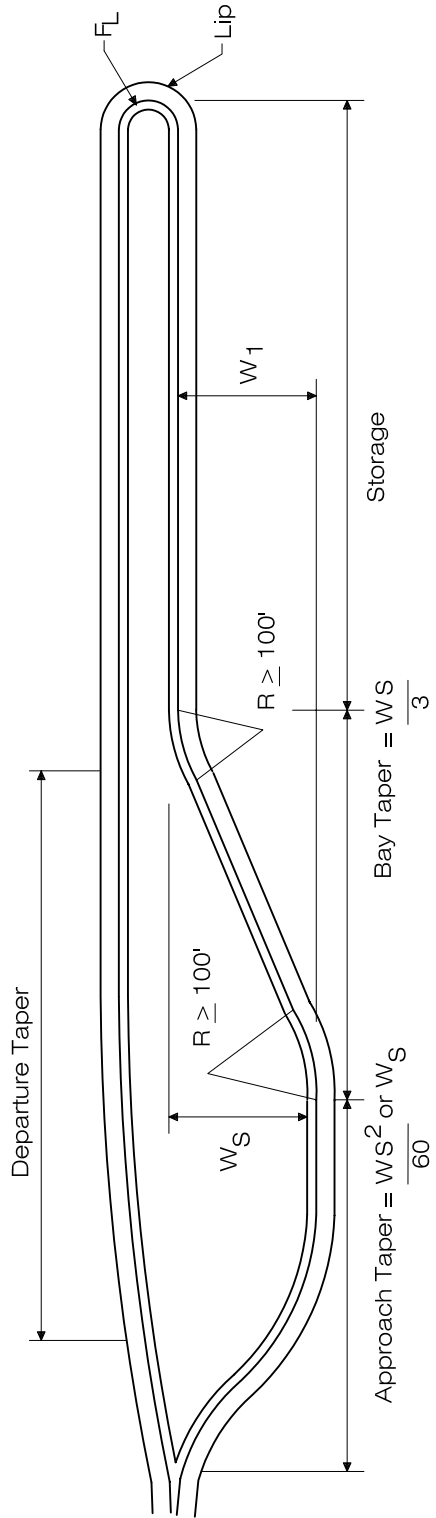

Left Turn Lane with Full Shadow

High Speed (≥ 45 MPH)

TAPER TYPE	TAPER RATIOS		
	DESIGN SPEED		
Bay	35	40	45
Approach	12:1	13.3:1	15:1
Depart	20:1	27:1	45:1
combined	NA	NA	NA
	20:1	27:1	45:1
			50:1

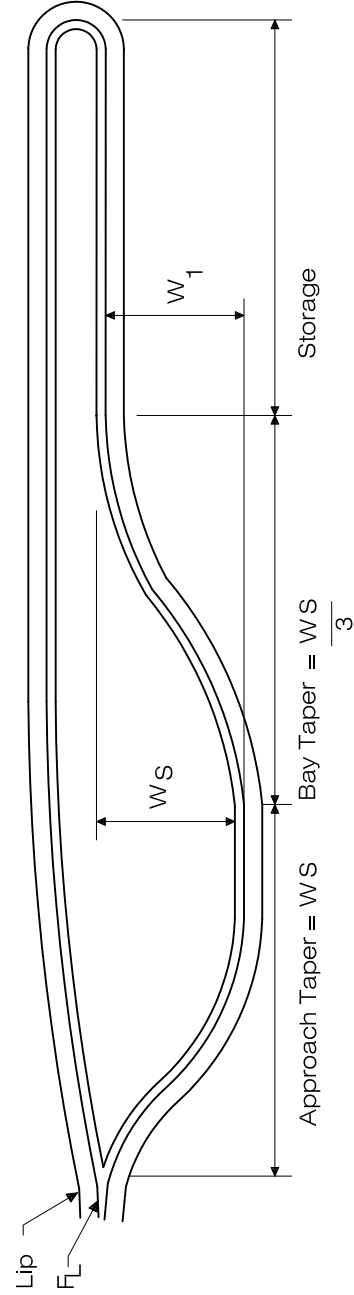

Left Turn Lane with Partial Shadow

NOTE: Refer to Figure 8-3 for design requirements.

TURN LANE DESIGN CRITERIA

LARIMER COUNTY
URBAN AREA
STREET STANDARDS

DESIGN
FIGURE

REVISION NO: 1
DATE: 03/01/02

FIGURE
8-11

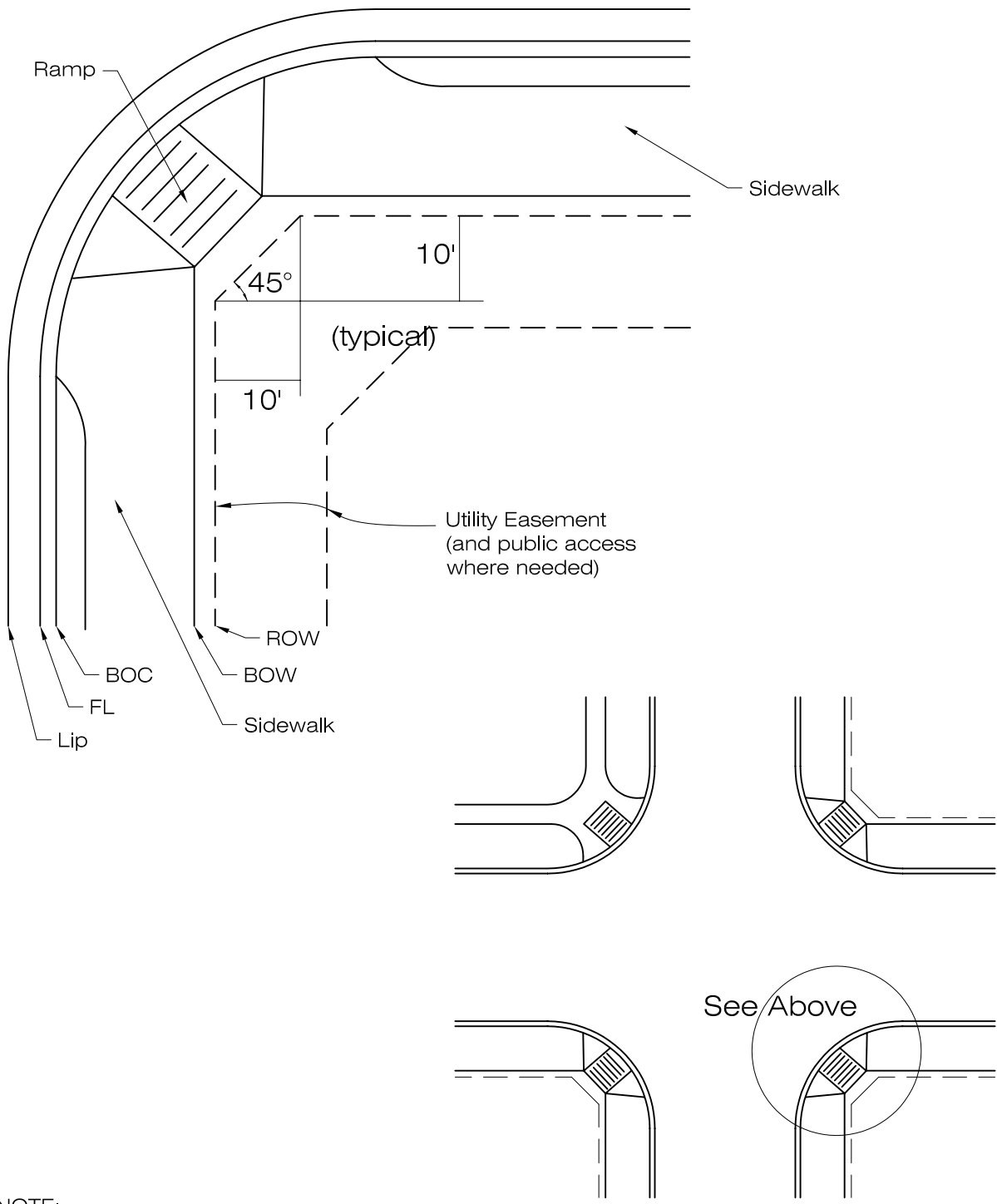

- NOTE:
1. Right of Way must be dedicated in the form of a radius or corner cut to include all of the required public improvements. However, sidewalk may be placed in a public easement when approved by the Local Entity Engineer.
 2. If intersection is determined to accommodate a roundabout in Loveland (GMA & City Limits), see **Figure 8-16L** for ROW requirements.
 3. Easements at the corner must be dedicated to provide corner cuts similar to ROW.

RIGHT OF WAY REQUIREMENTS AT INTERSECTIONS

LARIMER COUNTY URBAN AREA STREET STANDARDS	DESIGN FIGURE	REVISION NO:	FIGURE 8-12
		DATE: 08/07/00	

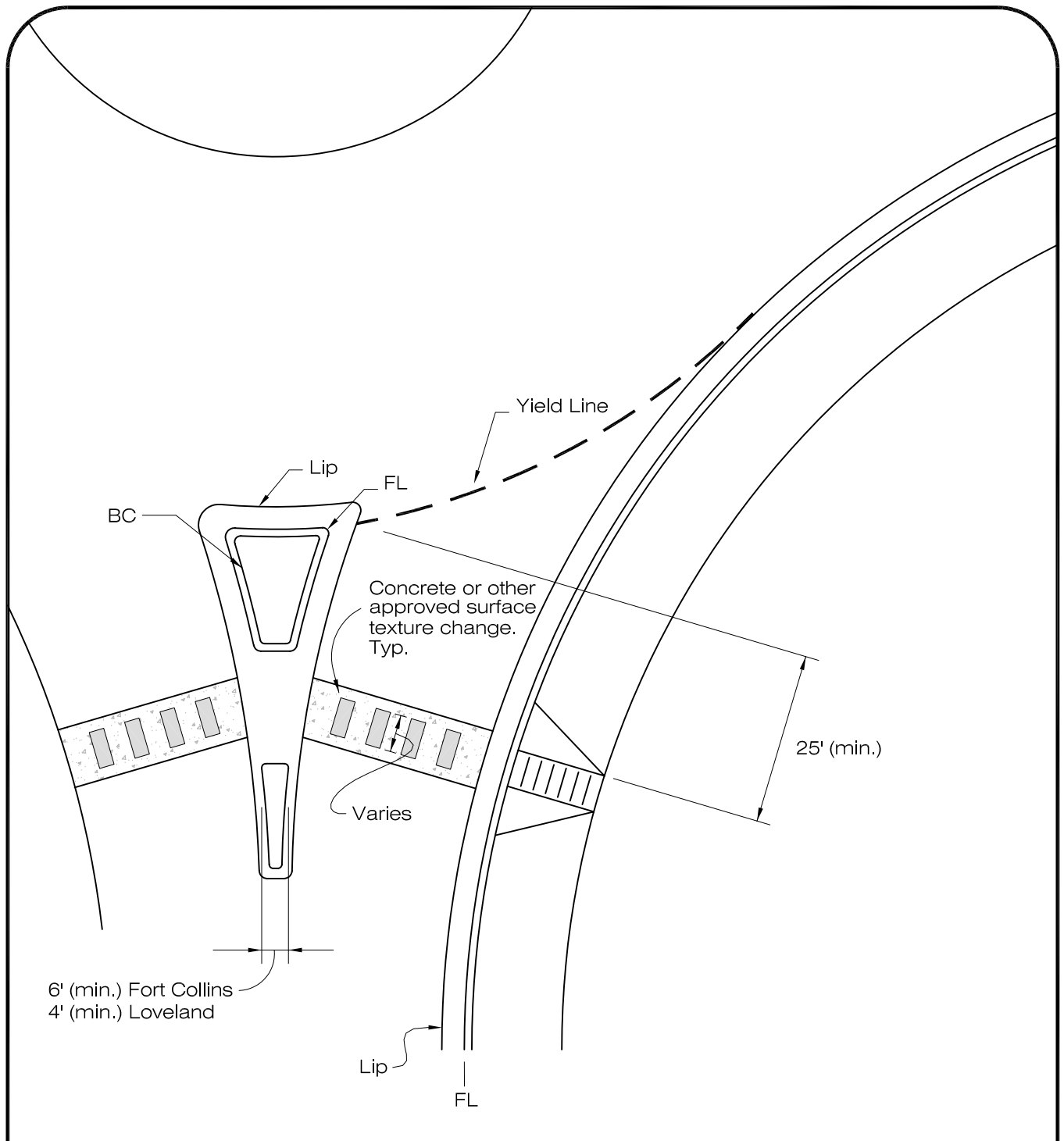

NOTES:

1. Each Splitter Island shall have a minimum width equal to the street classification sidewalk width and Refuge area that is in line with cross walks.
2. The specific design shall determine minimum radii and island lengths.
3. Raised crosswalk may be required by Local Entity.
4. Designer shall provide design to drain water out of pedestrian refuge.
5. Pedestrian refuge area shall be in line with crosswalks.
6. A mountable style curb and a decorative structural concrete surface shall be used for mini roundabouts that cannot accomodate WB50 and larger trucks solely on the roadway and truck apron surfaces.

SPLITTER ISLAND FOR MINI ROUNDABOUTS

LARIMER COUNTY URBAN AREA STREET STANDARDS	DESIGN FIGURE	REVISION NO: 1	FIGURE 8-13
		DATE: 03/01/02	

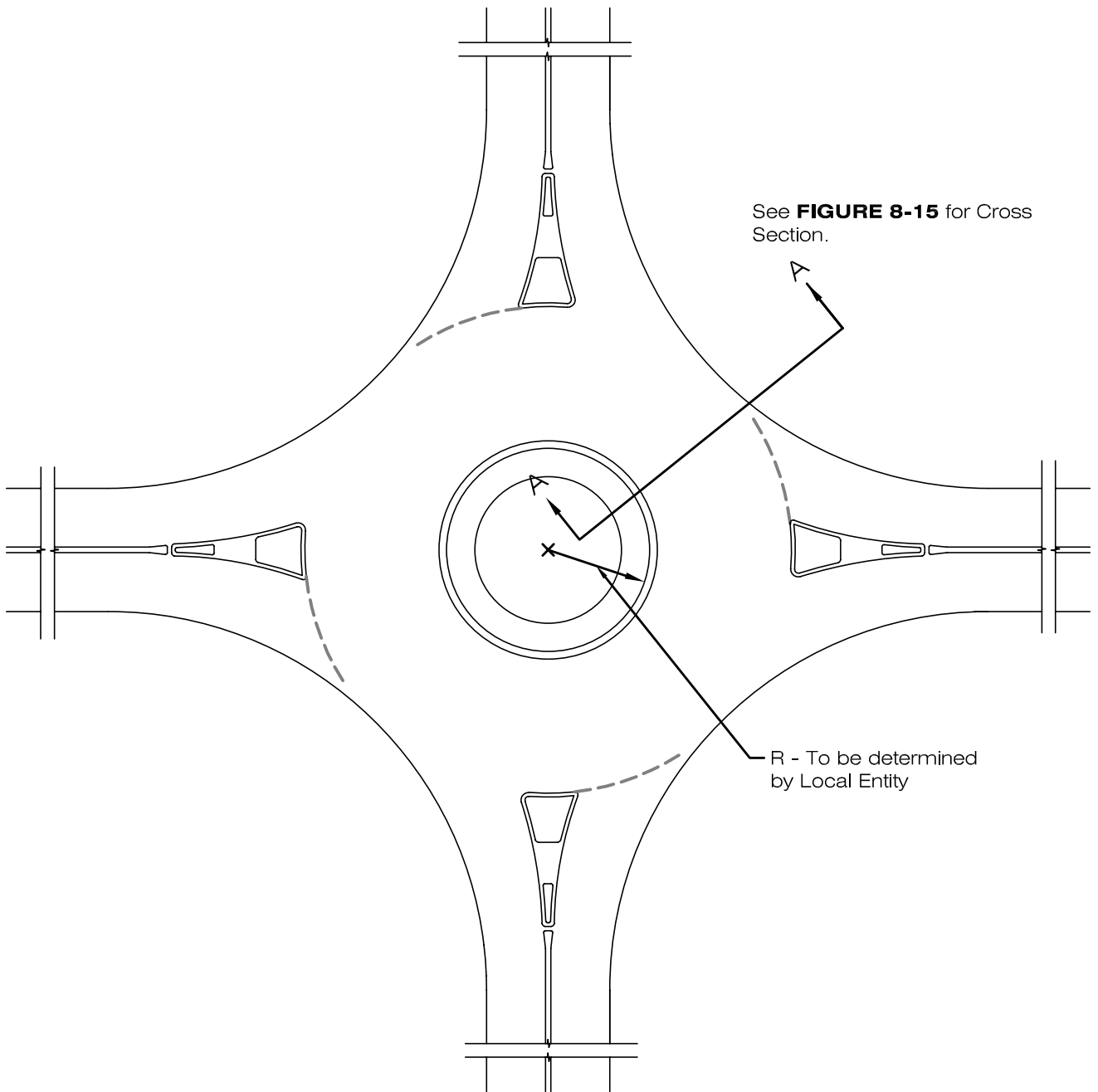

NOTE:

1. Refer to **Figure 14-2** for Mini Roundabout Sign Details & to **CONST. DWG. 802** for Barrier (Splitter Island) Details.

MINI ROUNDABOUT

LARIMER COUNTY
URBAN AREA
STREET STANDARDS

DESIGN
FIGURE

REVISION NO:	2
DATE:	04/01/07

FIGURE
8-14

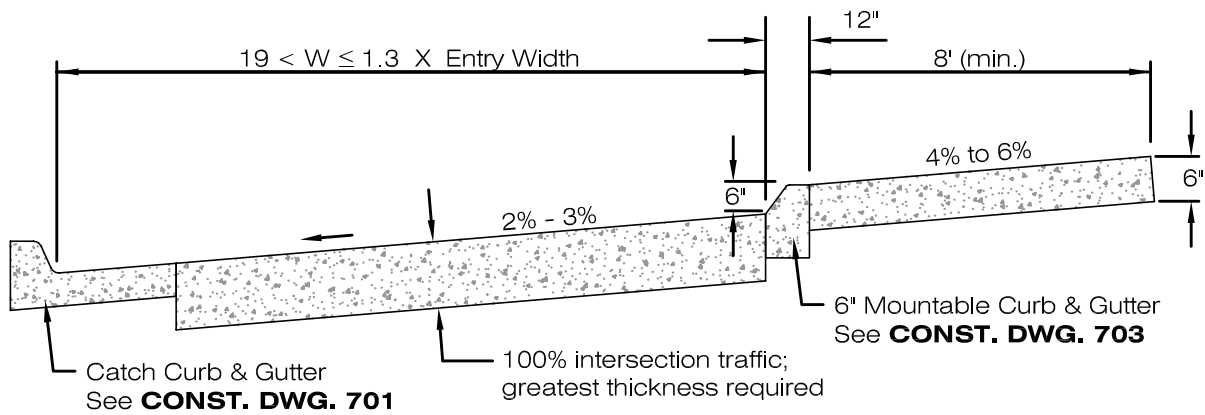
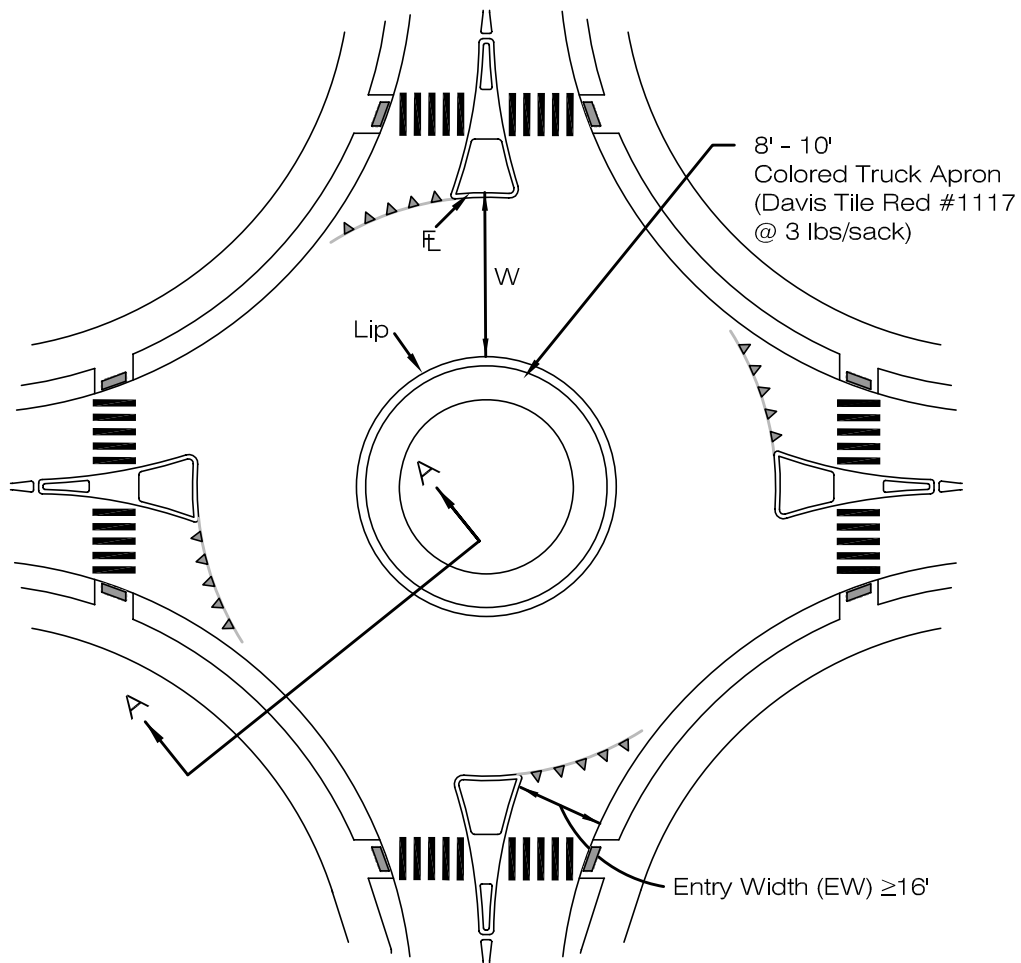

SECTION A-A

MINI ROUNDABOUT CROSS SECTION

LARIMER COUNTY
URBAN AREA
STREET STANDARDS

DESIGN
FIGURE

REVISION NO: 2
DATE: 04/01/07

FIGURE
8-15

LOVELAND ONLY

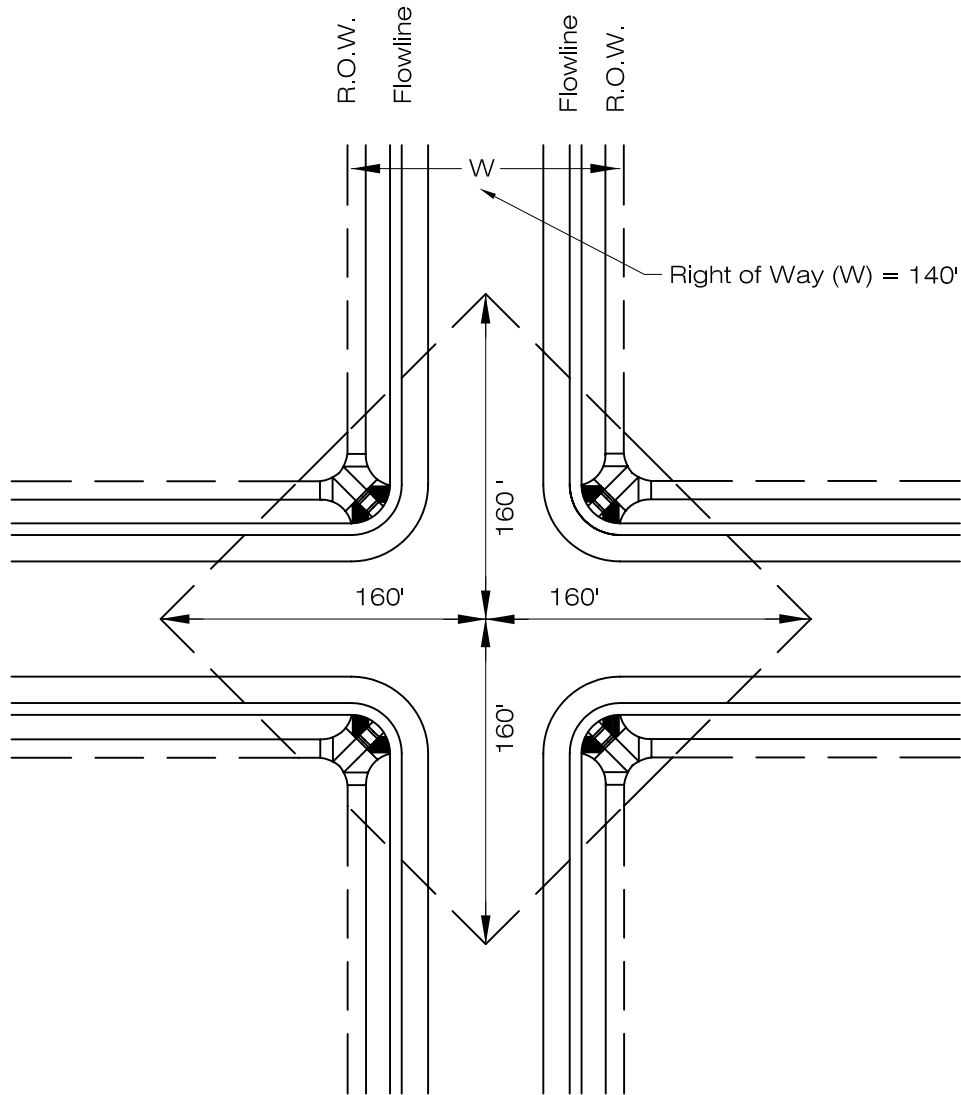

6 LANE ARTERIAL

NOTE:

The Local Entity may require the Developer to provide Right-of-Way for future Roundabout locations on any Major Collector or 2, 4 or 6 lane Arterial.

ARTERIAL INTERSECTION RIGHT-OF-WAY REQUIREMENTS

LARIMER COUNTY
URBAN AREA
STREET STANDARDS

DESIGN
FIGURE

REVISION NO:

DATE: 01/24/01

FIGURE

8-16L

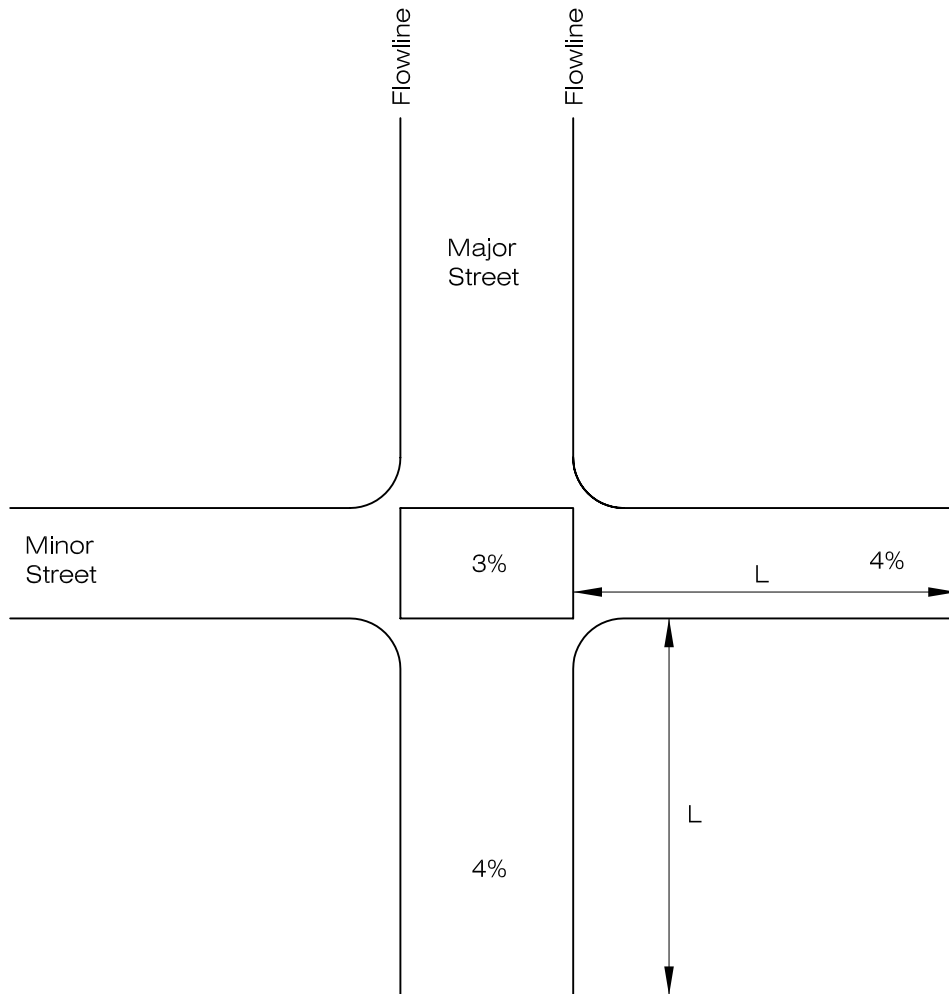

INTERSECTION GRADE CONTROL LENGTHS (L)

MINOR LEG	LOCAL	COLLECTOR	ARTERIAL
Private Drives	65 ft	65 ft	75 ft
Local	95 ft	100 ft	125 ft
Collector	100 ft	120 ft	200 ft
Arterial	125 ft	200 ft	200 ft

INTERSECTION GRADES

LARIMER COUNTY
URBAN AREA
STREET STANDARDS

DESIGN
FIGURE

REVISION NO:

DATE: 08/07/00

FIGURE

8-17

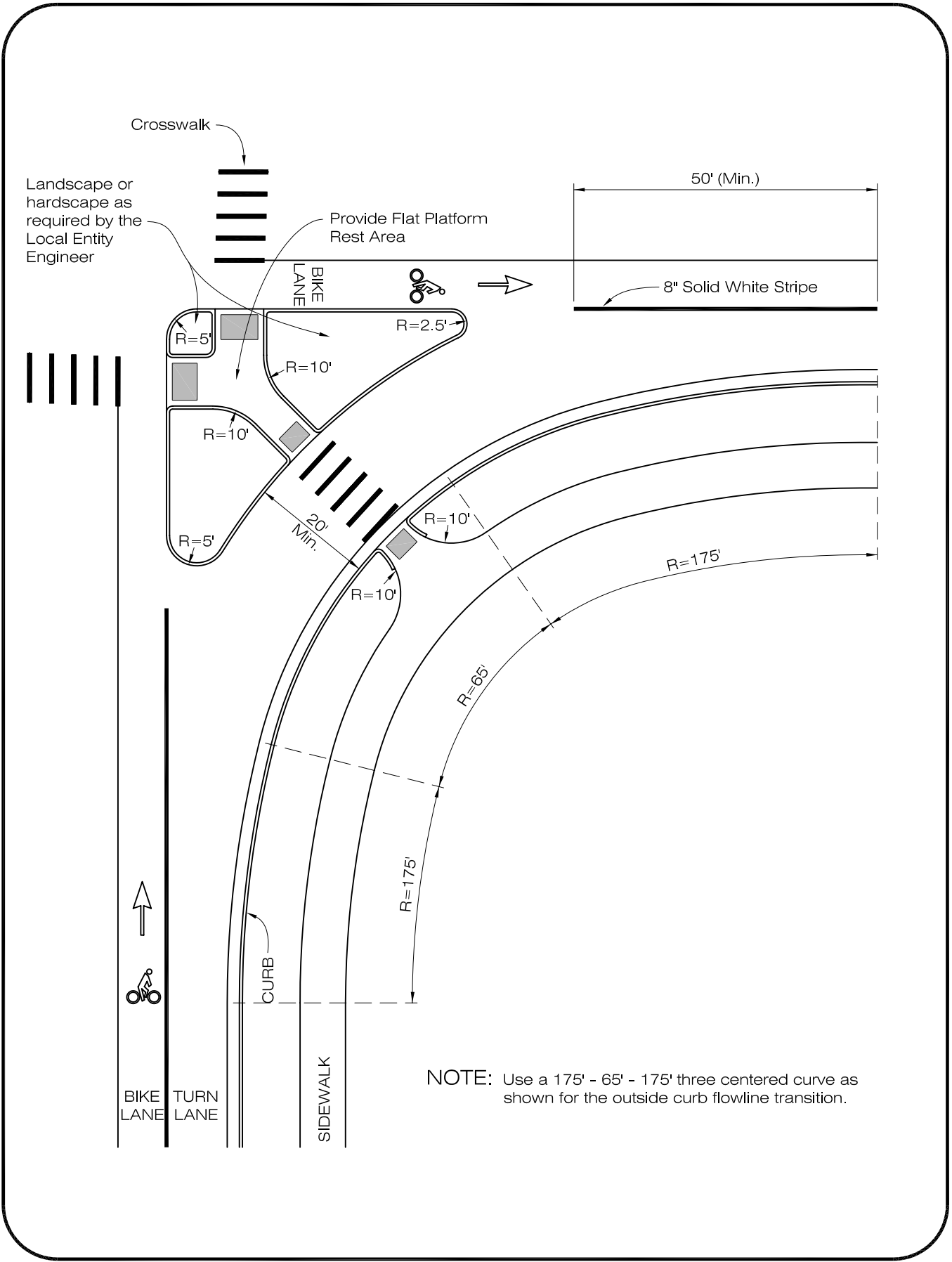

RT TURN LANE TO A CONTINUOUS LANE W/PED. REFUGE

LARIMER COUNTY URBAN AREA STREET STANDARDS	DESIGN FIGURE	REVISION NO:	FIGURE 8-18
		DATE: 02/02/01	

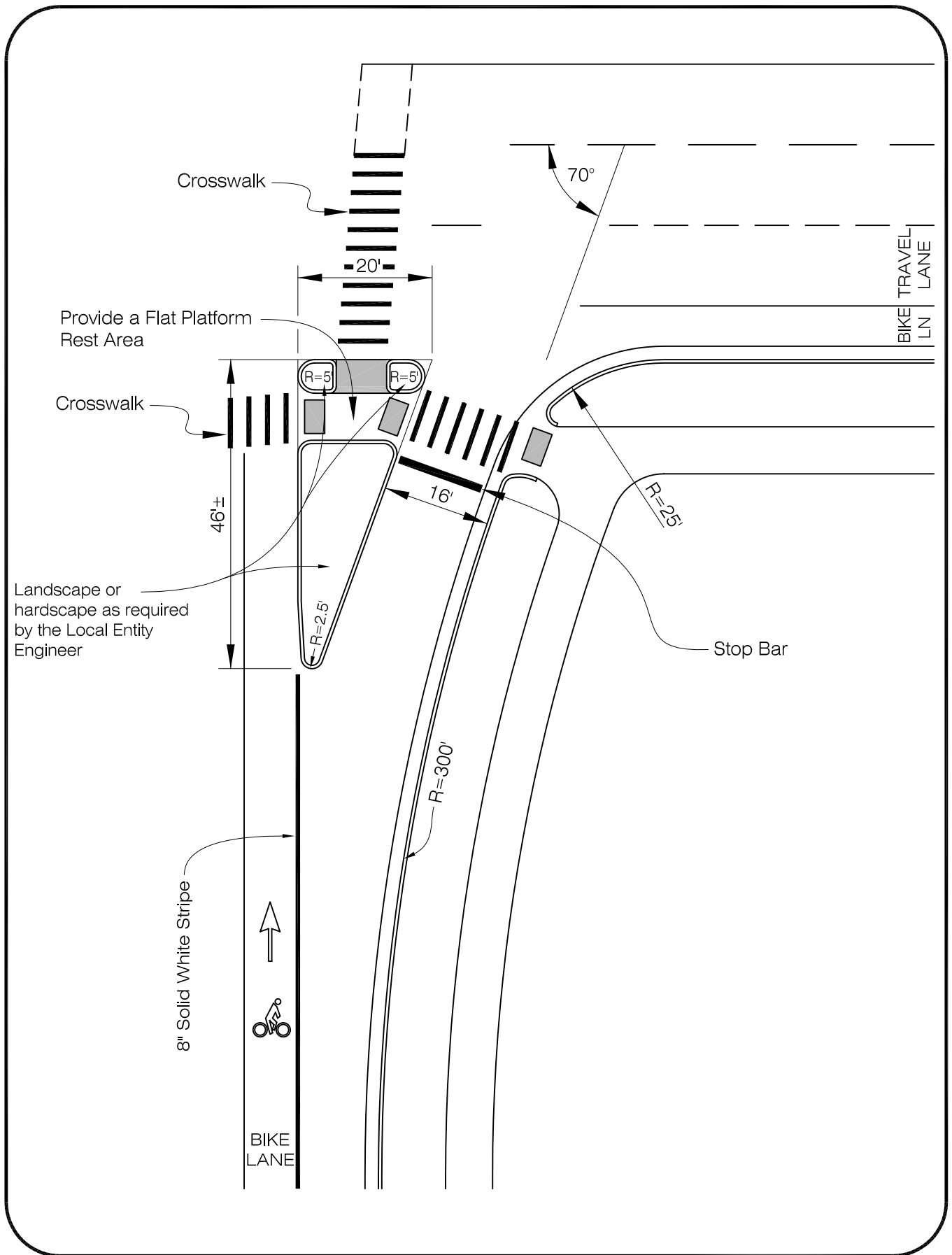

PEDESTRIAN REFUGE ISLAND/RIGHT TURN LANE

LARIMER COUNTY URBAN AREA STREET STANDARDS	DESIGN FIGURE	REVISION NO:	FIGURE 8-19
		DATE: 08/07/00	

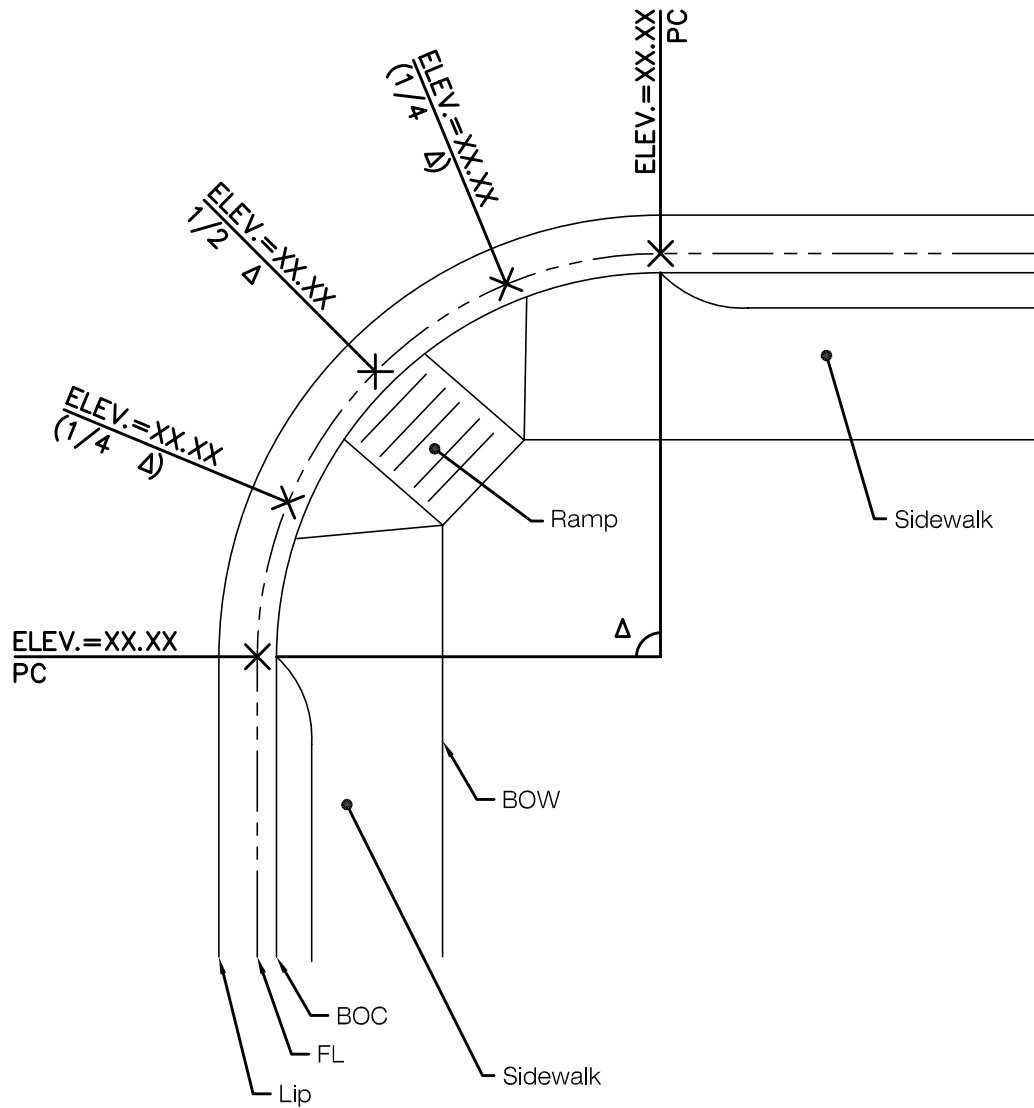

REQUIRED SPOT ELEVATIONS FOR CURB RETURNS

LARIMER COUNTY
URBAN AREA
STREET STANDARDS

DESIGN
FIGURE

REVISION NO:

DATE: 04/01/07

FIGURE

8-20

LOVELAND ONLY

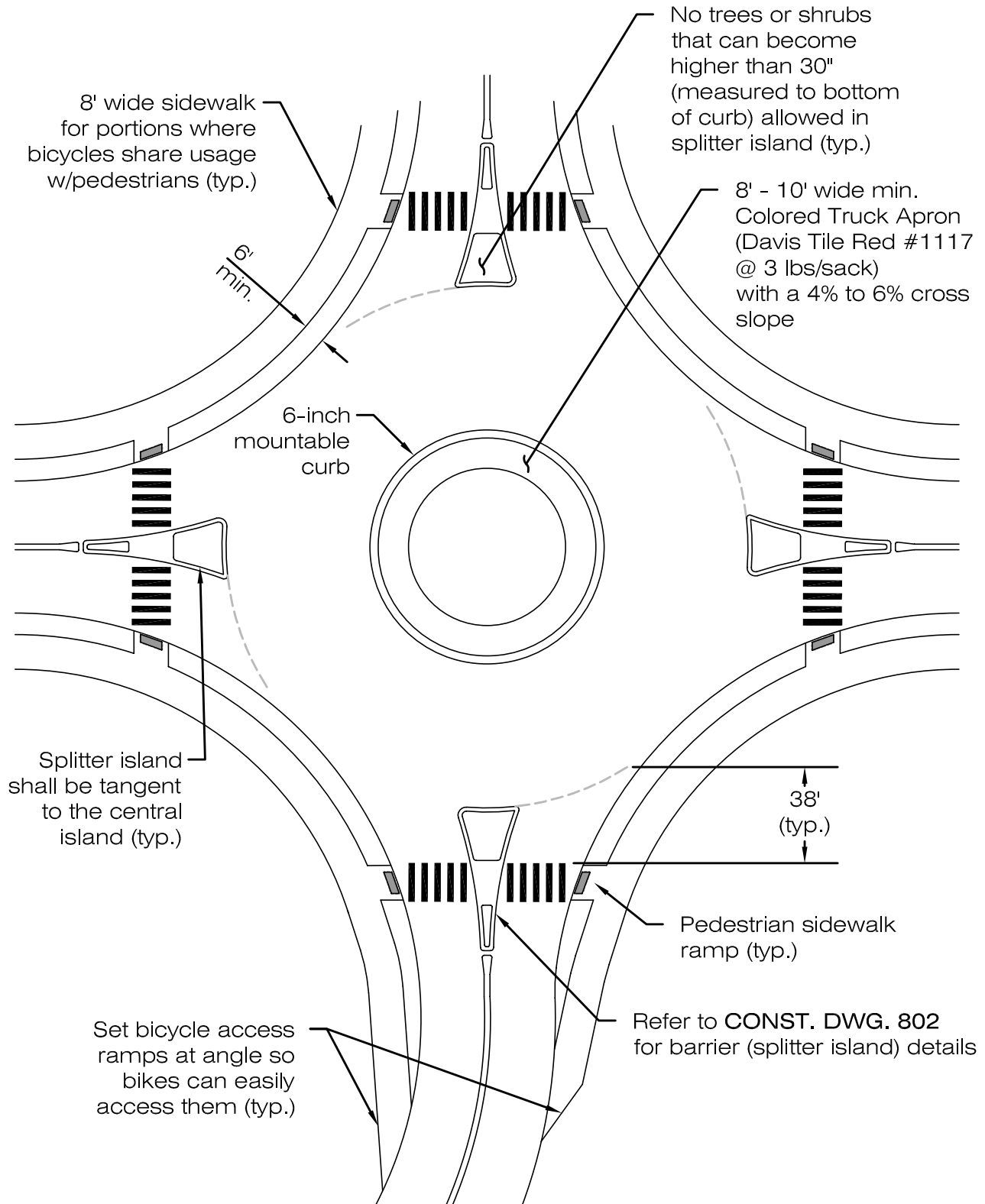

TYPICAL ROUNDABOUT

LARIMER COUNTY
URBAN AREA
STREET STANDARDS

DESIGN
FIGURE

REVISION NO: 2
DATE: 04/01/07

FIGURE
8-21